

NEW



NASTRO-SB™ L-Series

| | | | | | | |
|------------------|---------------|-----------|---------------|--------------|---------------|--------------|
| Automation Grade | SEMI | Fully | Use Intensity | Small | MEDIUM | HIGH |
| Format Setting | MANUAL | Automatic | Box Dimension | SMALL | MEDIUM | LARGE |

DATASHEET

SAFE • SUSTAINABLE • SMART

Semi-Automatic Case Sealer with LOGIC on-board

Nastro-SB™ L-Series is a range of semi-automatic case sealing machines designed and engineered by SIAT specifically for small to very large fix sized boxes. Nastro-SB™ L-Series is the ideal case sealing machine for a variety of industries like food & beverage, chemical, clothes and wine.

The machine offers a patented variable speed as standard and comes with a control panel for settings and user information. Its on-board Taping-Logic makes it the first intelligent taping machine. IoT integration is optional available with the SIAT Optirun System.

KEY FEATURES

- ✓ **Practical** - Seals upper & lower flaps of cardboard cases or cartons
- ✓ **Added Protection** - Lockable electric isolation switch
- ✓ **Safety First** - Central (L5) or double (L6 - L8) emergency stop to work safety on both sides of the machine
- ✓ **Taping Heads** - Available with K11 or K12 taping heads
- ✓ **Simple Operation** - Intuitive and quick machine set-up
- ✓ **Quality Build** - Best-In-Class components with SIEMENS electrics
- ✓ **Higher production capacity** - Thanks to patented variable speed
- ✓ **Improved Design** - Quick release Taping Heads (Top & Bottom – No tools required)
- ✓ **CE compliant** - Engineered and produced in Italy according to EU safety standards

MACHINE DIMENSIONS

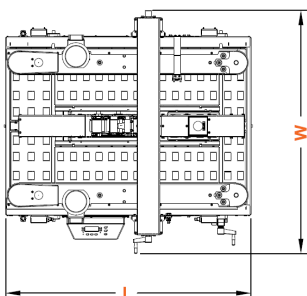
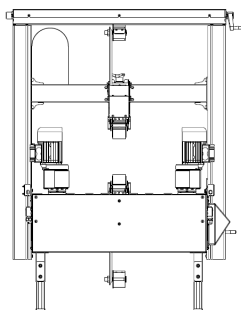
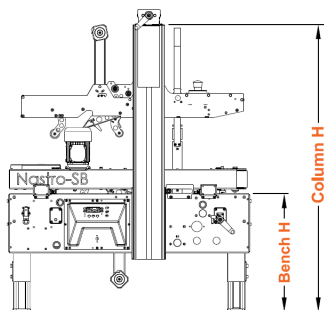

Also available:

- **L-Version**
for narrow and very low boxes
- **OB-Version**
for taping only on bottom side (w/o columns and top structure)



| Machine Dimensions | L5 | | L6 | | L8 | |
|--------------------|-------|-------|-------|-------|-------|-------|
| | Min | Max | Min | Max | Min | Max |
| H Column (mm) | 1.315 | 1.575 | 1.460 | 1.780 | 1.575 | 1.835 |
| H Bench (mm) | 540 | 800 | 540 | 800 | 540 | 800 |
| W (mm) | 1.085 | | 1.240 | | 1.390 | |
| W Bench (mm) | 800 | | 950 | | 1.100 | |
| L (mm) | 1.100 | | 1.100 | | 1.100 | |

| Standard Power Supply | |
|--------------------------|--------------|
| 220/240V – 50/60Hz - 1ph | |
| 440V – 50/60Hz - 3ph | |
| Amps | 3,4 |
| Power kW | 0,5 |
| Phase | 1Ph + N + PE |
| | 3Ph + N + PE |



NASTRO-SB™ L-Series



DATASHEET

LOGIC VERSION

Machines from Nastro-SB™ L-Series are originally equipped with a control panel, which allows you to set several parameters and indicates relevant information. The patented SIAT Taping Logic is always on board as well. It will take your taping performance to a next level.

- **Faster** than standard case sealers thanks to patented variable speed functions
- Possibility to **vary both acceleration and speed**
- Multiple combination available of acceleration and speed
- Increased productivity, thanks to the possibility to vary the two parameter - **production capacity up to 70%**
- Increased box management precision, all the valves are managed from the panel
- Better performances with lighter boxes
- **Rationalization** of tape consumption
- Additional opportunity to add the end / broken device alarm, managed by the panel
- Alarm device, directly on the panel
- Box per minute & box counter already present in the panel
- Settable **Energy Saving Mode** (Auto-Off) always included
- Better overall performances thanks to a photocell used instead of the previous pneumatic valves, that recognize even the lighter boxes



OPTIRUN SYSTEM

Optirun is an optional Remote Monitoring System developed in accordance with Industry 4.0 concept, with real-time monitoring of machine performance including tracking of the machine productivity in term of box per minute and tape usage for every box, these guarantees saving of resources and time as well as the total control of machine productivity, working time and tape consumption.

Machine overview and operational status – gives an instant view of machine dashboard and instantaneous parameters, such as real time monitoring of:

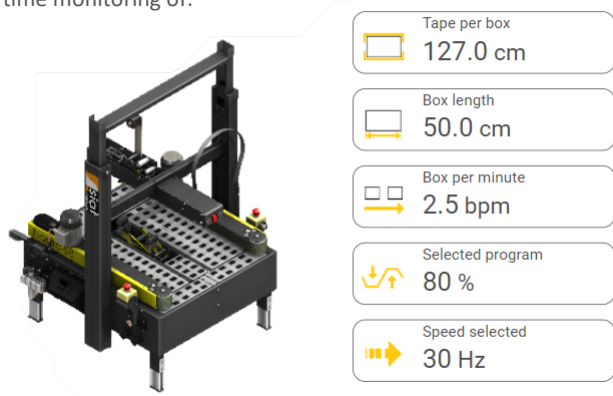

Statistics & Monitoring:

- Indication of the Operational Status of the machine – to monitor if the machine is fully used*
- Indication of the Machine Productivity – thanks to the box counter for started and completed cycle
- Tape Measurement – measures all tape consumed since the machine start-up and on average in centimeters per box
- Job recording, – to monitor the programs used, the cycle duration, the tape used, and the parameters selected
- Broken tape and failed cut counter, – if the end / broken alarm device is installed in the machine
- Active alerts and history – both consultable in the panel and with Optirun
- Maintenance & Configuration – possibility to access to predictive maintenance and service advice to reduce time
- Documentation – easy access to machine user manual

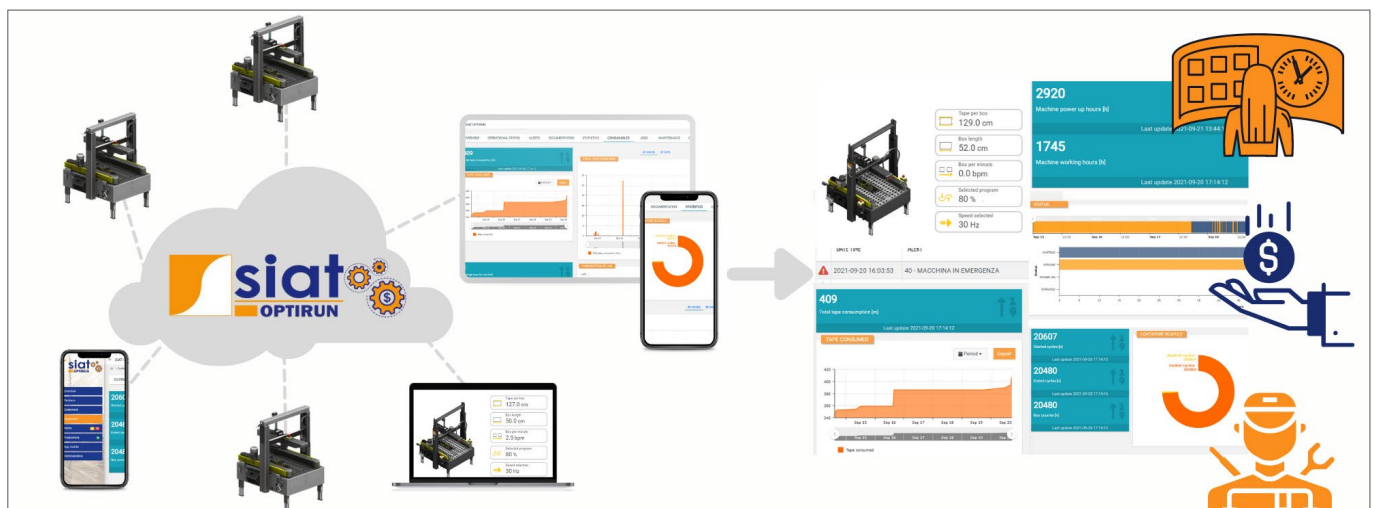

* Useful to understand if an additional machine is required. As a reference the ratio between Machine power per hour and Machine working hour must not exceed 90%

DATASHEET

Technical Data

| | |
|----------------------------------|------------------------------------|
| Belt position | Lateral (Left & Right) |
| Box Size | Medium / Large / Small (L-Version) |
| Min / Max box weight | 0,5 - 32 kg |
| Default Taping Head | L5: K11 for 2" = 50 mm |
| | L6/L8: K12 for 3" = 75 mm |
| Alternative Taping Heads | L5: K12 for 3" = 75 mm |
| | L6/L8: K11 for 2" = 50 mm |
| Power Consumption (std.) | 0,5 kw |
| Air Consumption (NL/Cycle) | - |
| Operator Side | Left (std.) / Right |
| Tape width (mm) | 50 / 75 |
| Tape Leg (mm) | 70 (std.) / 50 / 30 |
| Ingress Protection Code | IP54 |
| Ambient Operating Temperature | 5 – 40 °C |
| Maximum level of noise | Depending on tape quality |
| Features | |
| Removable Top Taping-Head | • (std. w/o tools) |
| Removable Bottom Taping-Head | • (std. w/o tools) |
| Adjustable Tape Leg | • |
| Pre-Installed & Easy-To-Mount | • |
| Adjustable Tape Contact Pressure | • |
| Autom. Box Format Setting | - |
| Flap Folding Function | • (opt. 3-flap-folder) |
| Belt Speed Selection | • |
| Fully Automatic Operation | - |
| SIAT Taping-Logic on board | • |

WORKBENCH HEIGHT

| Dimensions (mm) | |
|--------------------------|-----------|
| Workbench Height Z | 540 – 800 |
| Optional wheels* | + 110 |
| Optional elongated legs* | + 220 |
| Optional shorter legs* | - 100 |

* Indicated dimensions for optional wheels and legs must be added or subtracted from the basic dimensions.

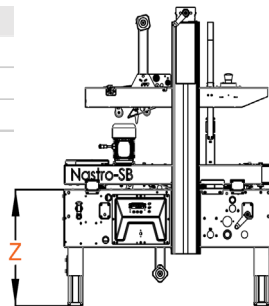

BOX DIMENSIONS & PRODUCTIVITY

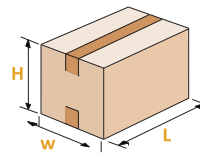

| Box Dimensions | | L5 | L6 | L8 |
|----------------|------|--------------------|-----|------------------|
| L (mm) | Min. | 150 | | |
| | Max. | ∞ | | |
| W (mm) | Min. | 150 ¹ | | |
| | Max. | 500 | 650 | 800 |
| H (mm) | Min. | 120 ^{1,2} | | 120 ² |
| | Max. | 500 | 650 | 800 |

¹ as L-Version: W = 105 mm
as L-Version & with tape-leg 30 mm: H = 50 mm

² 90 mm with 30 mm tape leg
100 mm with 50 mm tape leg
120 mm with 70 mm tape leg

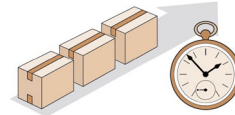

Max. production capacity:
Up to 1.600* BPH

*Based on the shortest processable box length and provided an optimum continuous box infeed by the operator.

PROCESSABLE TAPES

| | |
|---------------|---------------------------------------|
| Base Material | PVC / OPP / PET / Paper* |
| Adhesive Type | Solvent / Hot Melt / Acrylic |
| Special Tape | Filament-Tape** / Safety-Seal-Tape*** |

*with limitations **special tape cutting blade required ***need of a test might be necessary

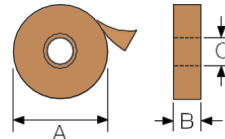

| K11R / K12R | |
|-------------|-------------|
| A | Max. 410 mm |
| B | 50 / 75 mm |
| C | 76 mm |

BOX REQUIREMENTS

Quality result of the taped box depends on the general box quality and dimensional accuracy, as well as the quality of tape used.

Box Types: FEFCO 0201 / 0200* – RSC / HSC*

[other types may be possible as well]

* FEFCO 0200 / HSC with OB-Version (only bottom taping) or on request

| | Underfilling | Overfilling | Weak Boxes |
|------------------------|--------------|-------------|------------|
| Adverse Impact Factors | | | |

OPTIONS & ACCESSORIES

- Operation side "Right" (std. "Left")
- Special cutting blades filament-tape
- Taping Head for 25/30 or 38mm width
- Power Supply 220/230V – 50hz – 1ph
- Higher Legs
- Casters / Wheels
- Fix & Extendable Roller Conveyors
- 3-Flap-Folder
- Box Holder
- End/Break Tape Device
- Optirun System

MORE DETAILS

Videos and further information can be found on our website or SIAT YouTube channel.

